

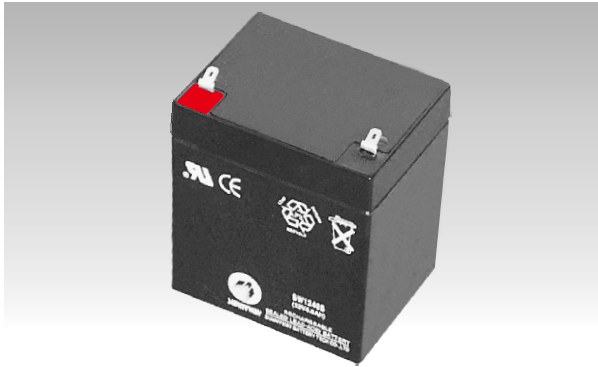

# SW1245(12V4.5AH)

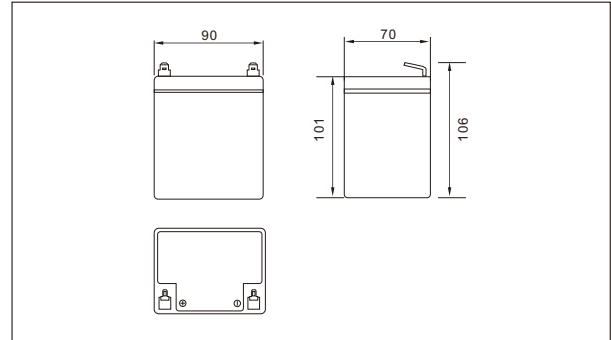

### Outer dimensions (mm)



### Specifications

Nominal Voltage		12V
Rated capacity (20 hour rate)		4.5Ah
Dimensions	Total Height	106mm (4.17 inches)
	Height	101mm (3.98 inches)
	Length	90mm (3.54 inches)
	Width	70mm (2.76 inches)
Weight Approx		1.48Kg (3.26 lbs)

### Terminal Type (mm)

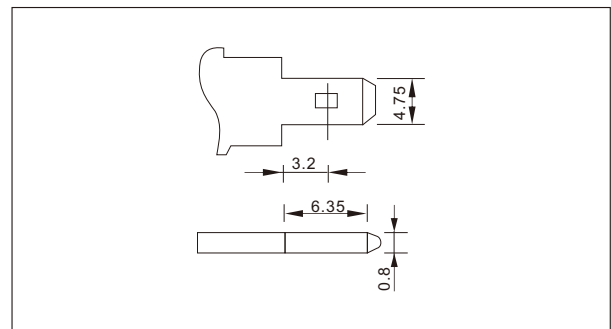

### Characteristics

Capacity 25°C(77°F)	20 hour rate(0.225A)	4.50 AH
	10 hour rate(0.41 A)	4.10 AH
	5 hour rate(0.77 A)	3.85 AH
	1 hour rate(2.70 A)	2.70 AH
	1.5 hour discharge to 10.5V	1.8 A
Internal Resistance	Full charged Battery at 25°C(77°F)	35 mΩ
Capacity affected by Temperature (20hour rate)	40°C(104°F)	102%
	25°C(77°F)	100%
	0°C(32°F)	85%
	-15°C(5°F)	65%
Self-Discharge at 25°C(77°F)	Capacity after 3 month storage	91%
	Capacity after 6 month storage	82%
	Capacity after 12 month storage	64%
Terminal		T1、T2
Charge (constant Voltage)	Cycle	Initial Charging Current less than1.80A Voltage 14.10-14.40V
	Float	Voltage 13.50-13.80V

### Discharge Curves 25°C(77°F)

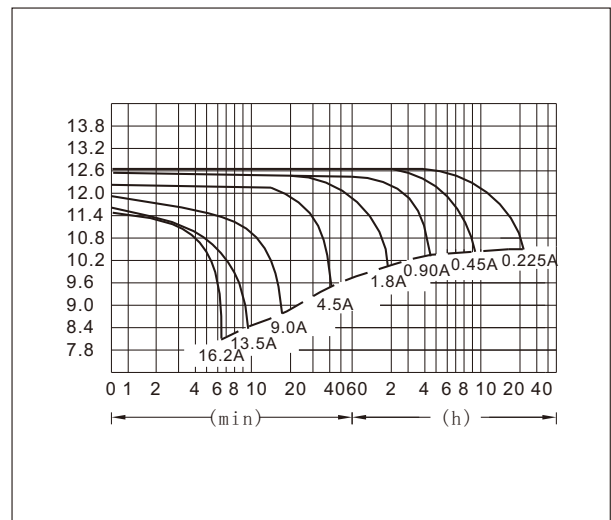

Constant Current(Amp) and Constant Power(Watt) Discharge Table at 25°C(77°F)

Time		5min	10min	15min	30min	1h	2h	3h	4h	5h	8h	10h	20h
9.60V	A	16.2	10.6	7.88	5.18	2.70	1.58	1.16	0.93	0.79	0.52	0.43	0.23
	W	191.1	120.0	90.8	54.9	31.1	18.2	13.41	10.76	9.13	6.02	4.93	2.70
10.20V	A	14.9	10.2	7.24	4.91	2.53	1.51	1.13	0.90	0.77	0.51	0.42	0.23
	W	179.8	113.6	85.3	54.6	29.3	17.5	13.03	10.43	8.96	5.93	4.84	2.62
10.50V	A	13.5	9.50	6.75	4.76	2.45	1.48	1.11	0.86	0.77	0.51	0.41	0.22
	W	173.6	110.3	81.6	54.0	28.4	17.2	12.81	9.90	8.91	5.87	4.80	2.61
10.80V	A	13.0	9.08	6.30	4.63	2.37	1.44	1.09	0.84	0.73	0.49	0.40	0.22
	W	152.2	106.9	78.6	53.8	27.6	16.8	12.66	9.78	8.51	5.63	4.69	2.55
11.10V	A	12.0	8.55	5.85	4.50	2.29	1.41	1.03	0.82	0.70	0.48	0.39	0.21
	W	147.2	103.3	74.8	53.4	27.2	16.7	12.28	9.75	8.33	5.44	4.59	2.53