

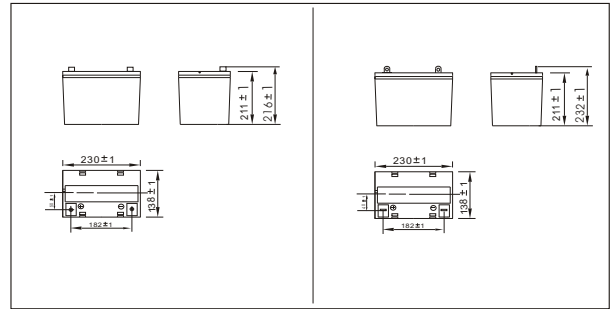

SWE12550(12V55AH)



Outer dimensions (mm)



Specifications

Nominal Voltage		12V	
Rated capacity (10 hour rate)		55 Ah	
Dimensions	Total Height	T9	232 mm (9.13 inches)
		T16	216 mm (8.43 inches)
	Height	208 mm (8.19 inches)	
	Length	230 mm (9.06 inches)	
Width		138 mm (5.43 inches)	
Weight Approx		17.2 Kg (37.9 lbs)	

Terminal Type (mm)

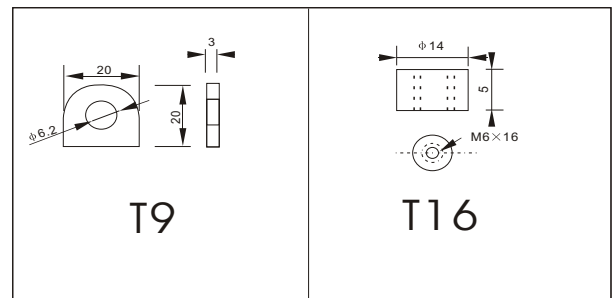

Characteristics

Capacity 25°C(77°F)	10 hour rate(5.5A) 5 hour rate(8.8A) 1 hour rate(33A)	55.0 AH 44.0 AH 33.0 AH
Internal Resistance	Full charged Battery at 25°C(77°F)	approx 6.0 mΩ
Capacity affected by Temperature (10hour rate)	40°C(104°F) 25°C(77°F) 0°C(32°F) -15°C(5°F)	102% 100% 85% 65%
Self-Discharge at 25°C(77°F)	Capacity after 3 month storage Capacity after 6 month storage Capacity after 12 month storage	91% 82% 64%
Terminal	T9、T16	
Charge (constant Voltage)	Cycle	Initial Charging Current less than 22 A Voltage 14.10-14.40V
	Float	Voltage 13.50-13.80V

Curves of cycle life(25°C)

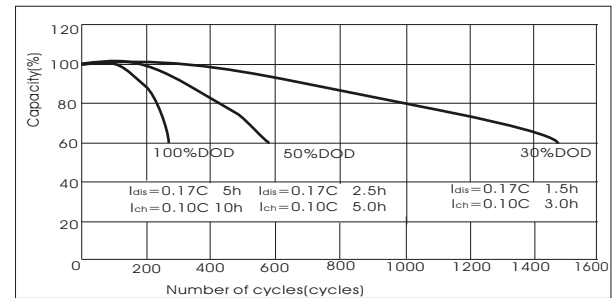

Discharge Curves 25°C(77°F)

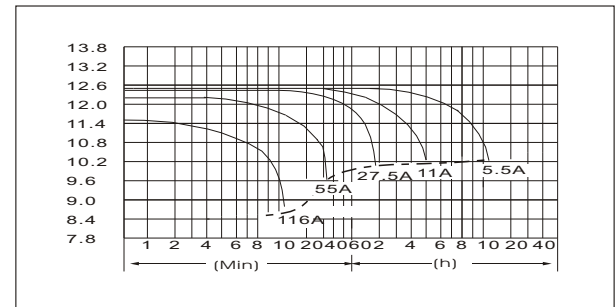

Constant Current(Amp) and Constant Power(Watt) Discharge Table at 25°C(77°F)

Time		5min	10min	15min	30min	1h	2h	3h	4h	5h	8h	10h	20h
960V	A	176	116	94	63	33.0	19.3	14.1	11.0	9.1	6.4	5.8	3.1
	W	1818	1239	1003	674	356.4	211.4	157.3	123.8	103.2	73.7	66.7	36.3
1020V	A	171	105	88	60	31.0	18.4	13.8	10.7	8.9	6.3	5.7	3.0
	W	1822	1169	986	673	350.8	211.7	159.2	124.7	103.9	73.4	66.6	35.5
1050V	A	165	94	77	56	30.0	17.9	13.4	10.6	8.8	6.2	5.6	3.0
	W	1802	1066	879	646	347.7	208.0	156.4	123.6	103.2	73.1	65.7	35.8
1080V	A	159	88	72	52	29.0	17.5	13.1	10.4	8.6	6.1	5.5	3.0
	W	1785	1018	825	599	338.0	204.8	154.3	122.7	101.4	71.7	65.4	35.4
1110V	A	154	83	66	46	28.1	17.1	12.7	10.1	8.4	5.9	5.2	2.8
	W	1743	958	770	541	329.9	201.5	150.3	120.5	99.8	70.5	63.1	34.0