

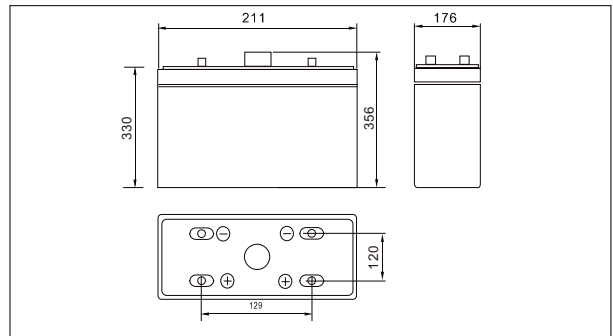

SW24000(2V400AH)



Outer dimensions (mm)



Specifications

Nominal Voltage		2 V
Rated capacity (10 hour rate)		400 Ah
Dimensions	Total Height	356 mm (14.0 inches)
	Height	330 mm (13.0 inches)
	Length	211 mm (8.31 inches)
	Width	176 mm (6.92 inches)
Weight Approx		25.0 Kg (55.1 lbs)

Terminal Type (mm)

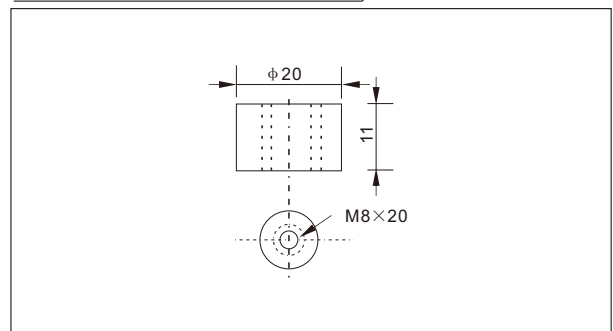

Characteristics

Capacity 25°C(77°F)	10 hour rate(40 A)	400 AH
	5 hour rate(64A)	320 AH
	1 hour rate(240 A)	240 AH
	1.5 hour discharge to 1.75 V	160 A
Internal Resistance	Full charged Battery at 25°C(77°F)	0.7 mΩ
Capacity affected by Temperature (10hour rate)	40°C(104°F)	102%
	25°C(77°F)	100%
	0°C(32°F)	85%
	-15°C(5°F)	65%
Self-Discharge at 25°C(77°F)	Capacity after 3 month storage	91%
	Capacity after 6 month storage	82%
	Capacity after 12 month storage	64%
Terminal		T20
Charge (constant Voltage)	Cycle	Initial Charging Current less than 100 A Voltage 2.35-2.40V
	Float	Voltage 2.25-2.30V

Discharge Curves 25°C(77°F)

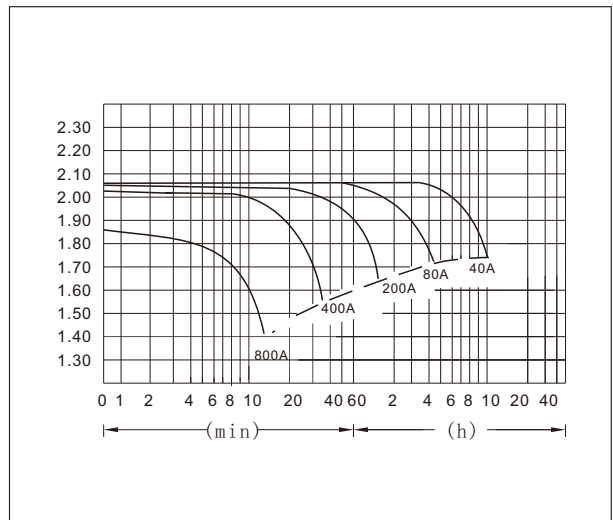

Constant Current(Amp) and Constant Power(Watt) Discharge Table at 25°C(77°F)

Time		10min	30min	1h	2h	3h	4h	5h	8h	10h	20h
		1.60V	A	796.0	456.0	240.0	140.0	103.2	80.0	67.37	46.3
	W	1564	816	464	272	200	156.0	128.0	88.0	82.0	43.6
1.70V	A	756.0	444.0	225.6	133.6	100.0	78.0	66.0	45.5	41.4	22.4
	W	1504	808	436	256	192	152.0	124.0	88.0	78.0	42.8
1.75V	A	716.0	408.0	220.0	130.4	97.6	76.8	65.4	45.0	40.8	22.1
	W	1456	760	420	252	188	148.0	122.4	86.8	77.2	42.0
1.80V	A	676.0	376.0	212.0	127.2	95.2	75.6	61.6	43.8	40.0	21.8
	W	1400	732	404	248	184	144.8	120.0	84.0	76.8	41.6
1.85V	A	636.0	336.0	200.0	124.0	92.0	73.3	60.4	42.7	39.0	21.6
	W	1320	672	392	244	184	142.0	119.2	80.4	76.0	41.0